



WHEN PERFORMANCE MATTERS

WEIGHT COUNTS

8 TON Ultra-LIGHT HIGH-Lift Jack

GS Engineering, Inc.

- **PROVEN & FIELDIED** equipment by the US Gov't
- **CAPABLE** of lifting up to **8 Tons (16,000 lbs)**
- **OPTIMIZED** design resulting in lean component weight, only **22 lbs**
- **VERSATILE** lifting range from **11 ¼" to 31"**
- **BUILT TOUGH** to exceed MIL-SPEC and ANSI performance standards
- **ADAPTABLE** telescoping handle lengths at 22" and 37¾" for maximum reach and advantage
- **RAPID** load lifting with dual-stage pump
- **PRECISE** load control by metered release system





SIMPLY POWERFUL READY TO MEET YOUR TOUGHEST NEEDS

The Ultra-LIGHT HIGH-Lift Jack from GS Engineering was developed for the most extreme military applications, and is currently fielded in theater. This unique jack solution is now available to meet your toughest commercial needs with confidence!

GS Engineering's Ultra-LIGHT HIGH-Lift Jack has been optimized for maximum lifting capacity in a lightweight, compact package that is quick and easy to deploy!

GS Engineering has proven production capabilities, and is prepared to meet additional high-volume production needs while maintaining the highest of quality standards. The design is also scalable to meet increased weight capacity or reduced lifting requirements.

Additional options and custom configurations can be easily provided to satisfy the needs of specific customer vehicle platforms.

Mounting Holes in Base

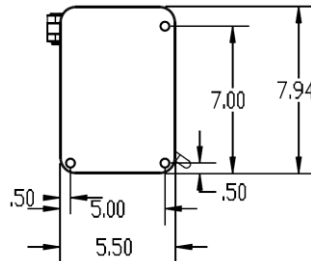

Jack Profile- Max/Min Height

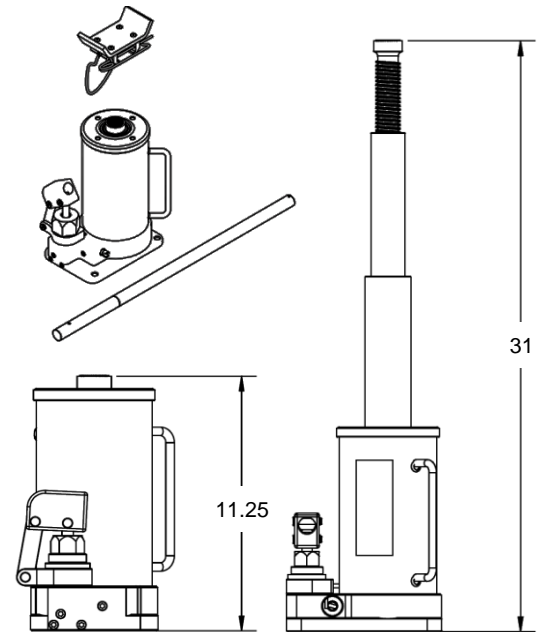

- Tested to MIL-STD-810G (sand/dust testing & corrosion resistance)
- Meets DoD & ANSI standards for vehicle lifting applications
- Meets ASME PALD-2009 (safety standard for portable automotive lifting devices)
- Optional lightweight base-plate & lifting saddle (shown above)
- Additional models available for varied load capacity & lifting applications (6.5 & 10 Ton)

PLEASE CONTACT US TO LEARN MORE



Corporate Office

47500 US Hwy 41
Houghton, MI 49931
tel: 906.482.1235
fax: 906.482.1236
www.gsengineering.com

Chris Coxon – Vice President

chris.coxon@gsengineering.com
mobile: 906.370.3710

Don Bigelow – Engineering Manager

don.bigelow@gsengineering.com
mobile: 906.370.3098